



DISPLAYS, PACKAGING & SIGNAGE



CONTENTS

ROLL UP BANNER DISPLAYS

Roll Up Lite	4
Roll Up Regular.....	5
Roll Up Prestige	5

COUNTER DISPLAYS

Menu/Display Holder	6
Rigid Brochure Holder	7
Counter Sign (POS).....	7
Roll up Mini	7

SIGNAGE

Street Talker Footpath Sign.....	8
PVC A-Frame	8
Timber A-Frame	8
Black & White Board Footpath Sign	8
Eco Footpath Sign	8
Heavy Duty Steel A-Frame	9
Mini A-Frame	9
Lawn Sign - Selmax.....	11
Free Standing Sign Holder	11

FLAGS

Teardrop Flag	12
Windblade Flag	12
Banner Flag	13
Stock Flag	13
Flag Base Options.....	13

FABRIC DISPLAY WALLS

8FT Fabric Frame Tube Wall.....	14
10FT Fabric Frame Tube Wall.....	15
Captain Wall	16



FENCE BANNERS & WRAPS	17
POP-UP COUNTERS	
Ezy Pop-Up Counter	18
Pop-Up Counter	18
DIGITAL CUTSOM CUTTING	19
WALL & FLOOR GRAPHICS	
Removable Wall Graphics	20
Custom Wallpaper	21
Window Frosting	21
WIDE FORMAT PRINTING MEDIAS	22
FLATBED PRINTING	23
MOUNTING OPTIONS	24
PACKAGING	26
OTHER PRODUCTS	
LED Indoor Light Box	28
Mitre Frame	28
Suspension Banner Rail	28
Canvas Print	29
Contour Cutting	29
Magnets	29
VEHICLE SIGNAGE	
Vehicle Signage	30
DIGITAL BILLBOARD	31

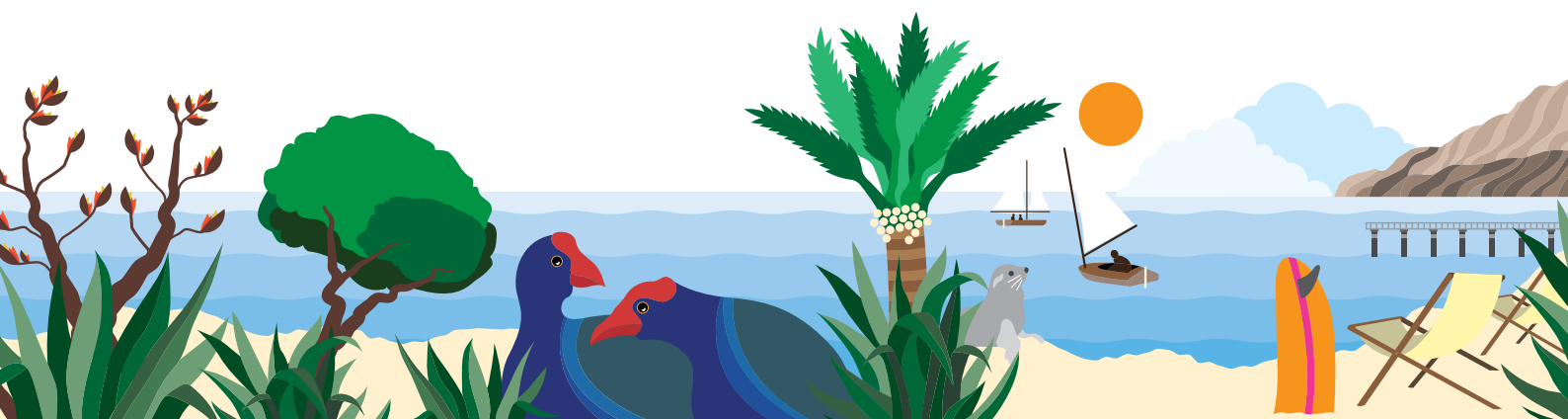



ROLL UP DISPLAYS



W: 600mm x
H: 1800mm



W: 850mm x
H: 2285mm

(Also available in black)

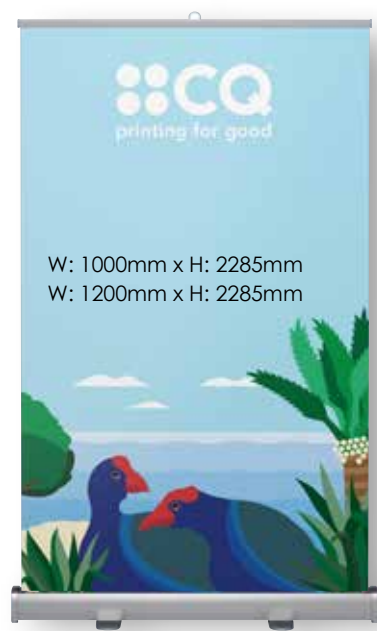

W: 1000mm x H: 2285mm
W: 1200mm x H: 2285mm

ROLL UP LITE

A lightweight and economical, free standing, retractable display suitable for light infrequent use.

This unit comes in an attractive metal finish. Easily transportable, the Roll Up Lite comes in a fabric carry bag.

Note: 285mm hidden in bottom of unit.

See our print template at cq.co.nz



ROLL UP REGULAR



A robust and professional looking, free standing, retractable display. The unit comes in an attractive metal finish.

The positive top clamp and adhesive bottom require no special finishing to your graphic. This easily transportable banner comes in a fabric carry bag.

See our print template at cq.co.nz



REGULAR DIMENSIONS

W: 600mm	x H: 1800mm	Weight: 3.2kg
W: 850mm	x H: 2285mm	Weight: 4kg
W: 1000mm	x H: 2285mm	Weight: 4.5kg
W: 1200mm	x H: 2285mm	Weight: 6kg

Note: 285mm hidden in bottom of unit.

WIDE DIMENSIONS

W: 1500mm	x H: 2285mm	Weight: 6.8kg
-----------	-------------	---------------

Note: 285mm hidden in bottom of unit.

Note: Synthetic Zeus media construction only.



ROLL UP PRESTIGE



SINGLE SIDED

An attractive looking, free standing retractable display. Lightweight and easy to assemble.

This unit comes in black or silver with chrome end caps. The clamping system at the top and self adhesive attachment at the bottom require no special finishing to your graphic.

This banner comes in a fabric carry bag.

DIMENSIONS

W: 830mm	x H: 2285mm	Weight: 5.5kg
W: 960mm	x H: 2285mm	Weight: 6kg

Note: 285mm hidden in bottom of unit.



DOUBLE SIDED

A double sided version of the Prestige, allowing graphics to be displayed front and back. The unit comes in an attractive black or silver with chrome end caps.

Rear cavity size is limited so only light medias can be used. This easily transportable banner comes in a fabric carry bag.

DIMENSIONS

W: 830mm	x H: 2285mm	Weight: 6kg
----------	-------------	-------------

Note: 285mm hidden in bottom of unit.

See our print template at cq.co.nz



COUNTER SIGNS & DISPLAYS



●● MENU / DISPLAY HOLDER

STYLISH & FUNCTIONAL POSTER
& MENU HOLDER

- Adjust to display either landscape or portrait
- Angle and telescopic height adjustment
- Silver anodised aluminium finish
- Stock sizes - A4, A3 and A2

Check it out in our showroom

•• RIGID BROCHURE HOLDER

A Rigid Brochure Holder with 4 acrylic shelves that fold down into a compact carry size for transportation.

The brochure holder has four spaces for A4 sized brochures. Includes carry bag.

DIMENSIONS

W: 260mm x H: 1560mm



CARRY CASE



•• COUNTER SIGNS (POS)

SINGLE WING & DIECUT

Counter easels are an eye-catching display product, perfect for reception areas, counters and trade shows.

A sturdy counter display, best mounted with one of our foam backing boards. Choose from a variety of finishes to create a sleek, professional finish, or use one of our 100% recyclable boards.

DIMENSIONS

Available in standard sizes:
A5, A4, A3, A2, A1 & odd sizes.



•• ROLL UP MINI



A4 AND A3 SIZES

Desktop version of a roll up display, available in A4 and A3 graphic sizes.

This table top mini display system is great for highlighting products, special offers or promotional giveaways.

DIMENSIONS

A4 W: 210mm x H: 297mm Weight: 0.4kg

A3 W: 297mm x H: 420mm Weight: 0.5kg



SIGNAGE

STREET TALKER FOOTPATH SIGN

The industry standard Foot Path Sign. The base can be filled with sand or water for extra stability.

You can also order new blades separately.

Available with or without handle hole.

SIGN DIMENSIONS (INCLUDING BASE)

W: 600mm x H: 800mm

VISIBLE GRAPHIC DIMENSIONS

W: 600 x H: 755mm



PVC A FRAME FOOTPATH SIGN

Inexpensive entry level foldable Foot Path Sign

SIGN DIMENSIONS

W: 450mm x H: 610mm

VISIBLE GRAPHIC DIMENSIONS

W: 450mm x H: 610mm



☼ TIMBER A-FRAME

A traditional, natural timber sandwich board display.
Suitable for indoor or outdoor use.
Easy to fold and carry.

SIGN DIMENSIONS

W: 660mm x H: 1000mm

GRAPHIC DIMENSIONS

W: 605mm x H: 810mm



☼ BLACK & WHITE BOARD FOOTPATH SIGN

Black & White Board Media with Quick Base

Quick Base

Charcoal coloured base, designed and made in Italy.
Looks great and made to last!

We have sourced two new medias specially designed for chalk and white boards. These are top quality products that clean up after use really well.
We can use these in conjunction with other media, and they are particularly useful for street signs or sandwich boards.

White Board Media

Designed for great results with white board markers.

Black Board Media

A stick on media that works as a black board.



☼ ECO FOOTPATH SIGN

Plywood Media with Quick Base

Quick Base

Charcoal coloured base, designed and made in Italy.
Looks great and made to last!

Ply Board (12mm)

We can print direct to a sheet of Plywood, we can also use our white ink!

Sign Dimensions

W: 600mm x H: 850mm



HEAVY DUTY STEEL 'A' FRAME

Corflute, Palight or ACM Signboard

Heavy Duty A-Frame with Signboard

Sturdy black steel frame.

Super easy to change out graphics.

Retractable Handle

Available with single or two signs inserted.

FRAME SIZE

W: 625mm x H: 1050mm

GRAPHIC SIZE

W: 605mm x H: 918mm

Note: With graphics needed for front and back

VIEWABLE AREA

W: 585mm x H: 902mm



MINI A-FRAME

The ultra portable Mini A-Frame

The Mini A-Frame folds completely flat for storage and the graphic area folds to the inside protecting the image from damages while in transit. To deploy, simply fold one side over making an A shape. The weighted feet make the unit stable in light to moderate wind conditions. Ideal for use as a temporary directional signage, real estate open home signs, coffee and food vans, sporting events signage etc.

DIMENSIONS

W: 600mm x H: 450mm

Image on both sides



Folded with graphic protected inside

☼ LAWN SIGN - SELMAX

Great for open days, event signs & real estate
Frame available in black or white. Printed on corflute.
Injection moulded sign holders, moulded from engineering plastic for durability and aesthetic appeal.
One piece sign and lightweight, interchangeable graphics.

SIGN DIMENSIONS

W: 475mm x H: 570mm

GRAPHIC SIZE

W: 450mm x H: 300mm

Note: need graphics for front & back



☼ FREE STANDING SIGN HOLDER

(1/2 PANEL)

Sturdy black steel, Free Standing Sign Holder.
Super easy to change out graphics.
Single or double sided graphic.

VISIBLE GRAPHIC SIZE

W: 524mm x H: 678mm

BOARD SIZE

W: 560mm x H: 710mm

UNIT SIZE

W: 600mm x H: 1554mm

WEIGHT: 15KG



☼ FREE STANDING SIGN HOLDER

(FULL PANEL)

Sturdy black steel, Free Standing Sign Holder.
Super easy to change out graphics.
Single or double sided graphic.

VISIBLE GRAPHIC SIZE

W: 524mm x H: 1408mm

BOARD SIZE

W: 560mm x H: 1425mm

UNIT SIZE

W: 600mm x H: 1554mm

Weight: 15kg





FLAGS

Allow 12-14 working days for flag orders



TEARDROP FLAGS

OUR MOST POPULAR FLAG

Teardrop Flags (Model A)

Available in three sizes. The poles are durable fibre-glass and each unit comes in a carry bag.

Available in single or double sided print.

Comes with soft fabric carry bag & pole

FLAG SIZE

Small - 810 x 1820mm
 Medium - 1104 x 2610mm
 Large - 1360 x 3790mm

BASE SOLD SEPARATELY



WINDBLADE FLAGS

WINDBLADE FLAGS (MODELS B,C,D & E)

Available in three sizes and four shapes.

The poles are durable fibre-glass and each unit comes in a carry bag.

Available in single or double sided print.

Comes with soft fabric carry bag & pole

BASES SOLD SEPARATELY

HEIGHT

Small - 2500mm
 Medium - 3500mm
 Large - 4700mm

FLAG SIZE

Small - 630 x 2000mm
 Medium - 640 x 2960mm
 Large - 780 x 4010mm

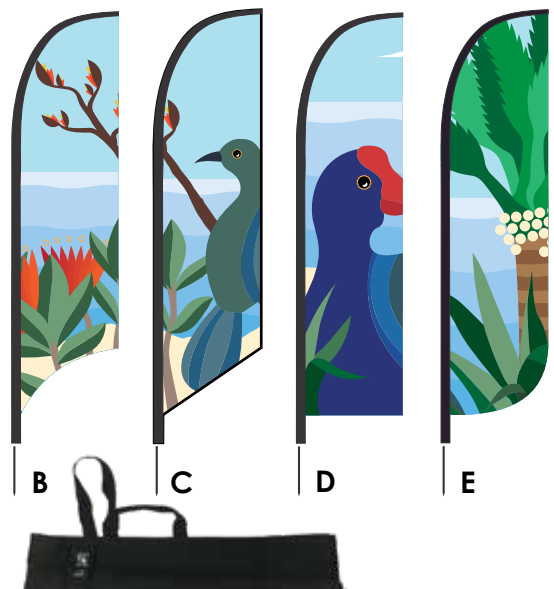

FLAG BANNERS

Swingarms are created to custom sizes. The poles are durable aluminium and each unit comes in a carry bag. The vertical pole is telescopic so the height can be set between 1220mm and 3000mm. The flag can be produced at any size required. See below for typical sizes.

Comes with soft fabric carry bag & pole

BASES SOLD SEPARATELY

Available in single or double sided print.
(Large size only available in single sided)

HEIGHT

Small - 2100mm
Medium - 2900mm
Large - 4100mm

FLAG SIZE

Small - 700 x 1680mm
Medium - 700 x 2500mm
Large - 700 x 3450mm



STOCK FLAGS

We have a range of off the shelf flags (Sale, Open Home, Cafe, Open, Coffee, Food) subject to availability.

A great way to get a inexpensive & fast flag.

Single sided only.

FLAG SIZE

W: 620mm x H: 2440mm



Comes with soft canvas carry bag & pole.

CROSS FOOT OR GROUND SPIKE BASE PURCHASED SEPARATELY

FLAG BASE OPTIONS



Cross Foot



Ground Spike



Wheel Stand



Water Bladder



Water Base
Without Wheels



Flat Base



Tow Ball



Angled
Wall Mount



180 Degree
Wall Mount



90 Degree
Mount



60 Degree
Tent/Post



FABRIC DISPLAY WALLS

Allow 12-14 working days for Display Wall orders

8FT FABRIC FRAME TUBE WALL



8FT STRAIGHT

DP-TB-S8

Available with single sided or double sided graphics.
Replacement graphics/skins available.

DIMENSIONS

Display Size: W 2440mm x H 2280mm
Graphic Size: W 2500mm x H 2340mm
Weight 7kg

Display comes with a durable carry bag

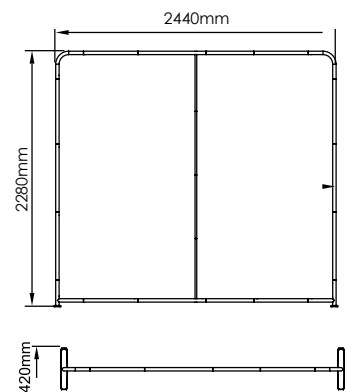

10FT FABRIC FRAME TUBE WALL



8 FT CURVED

DP-TB-C8

Available with single sided or double sided graphics. Replacement graphics/skins available.

DIMENSIONS

Display Size: W 2570mm x H 2280mm
 Graphic Size: W 2630mm x H 2340mm
 Weight 8kg
 Display comes with a durable carry bag

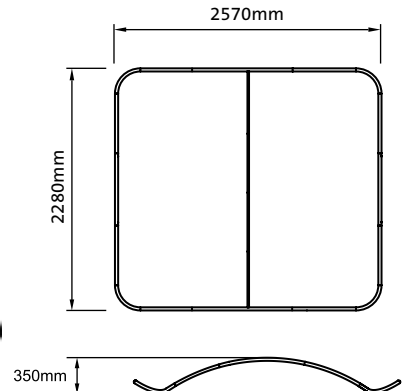

10FT STRAIGHT

DP-TB-S10

Available with single sided or double sided graphics. Replacement graphics/skins available.

DIMENSIONS

Display Size: W 2920mm x H 2280mm
 Graphic Size: W 2980mm x H 2340mm
 Weight 7.5kg
 Display comes with a durable carry bag

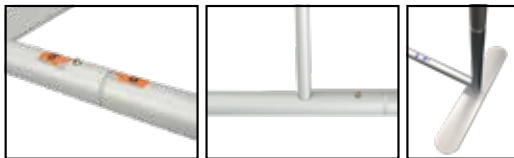
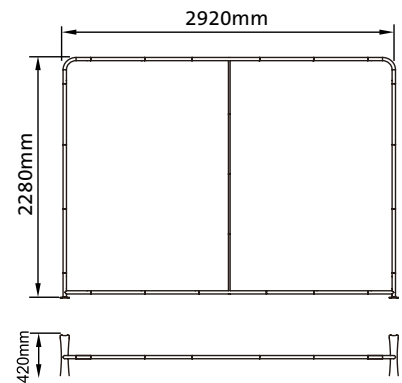

10FT CURVED

DP-TB-C10

Available with single sided or double sided graphics. Replacement graphics/skins available.

DIMENSIONS

Display Size: W 3190mm x H 2280mm
 Graphic Size: W 3250mm x H 2340mm
 Weight 10kg
 Display comes with a durable carry bag

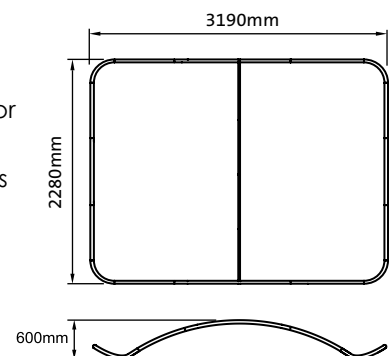

FABRIC TUBE WALL

CAPTAIN 600
DP-TW-H60

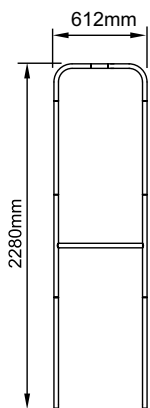

CAPTAIN 900
DP-TW-H90

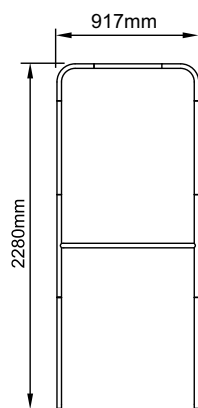

CAPTAIN 1200
DP-TW-H120

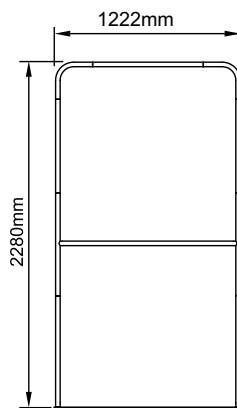

CAPTAIN 1500
DP-TW-H150

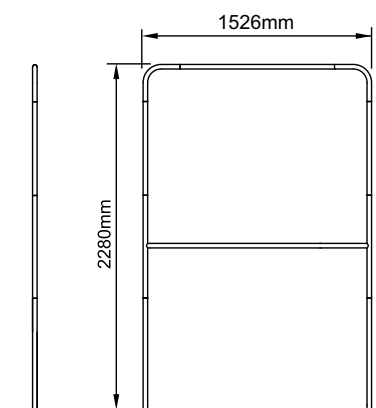

ITEM: CAPTAIN FABRIC STAND

VISIBLE	612 x 2220mm	917 x 2220mm	1222 x 2220mm	1526 x 2220mm
GRAPHIC	660 x 2280mm	970 x 2280mm	1270 x 2280mm	1570 x 2280mm
GROSS WEIGHT	7.00kg	9.00kg	11.00kg	14.00kg
QTY/CTN	1pc	1pc	1pc	1pc



FENCE WRAPS & BANNERS

Maximise your brand exposure & make your site secure & private. All fence wraps come with welded hems for extra strength & durable metal eyelets at 400mm spacings. We have three grades to choose from; Max, Lite or Flow.

MAX	
STRENGTH	<div style="width: 100%; height: 10px; background-color: #0056b3;"></div>
HIGH WINDS	<div style="width: 25%; height: 10px; background-color: #0056b3;"></div>
PRIVACY	<div style="width: 100%; height: 10px; background-color: #0056b3;"></div>
PRINT QUALITY	<div style="width: 100%; height: 10px; background-color: #0056b3;"></div>

Max is your go to product for quality images. It's close weave gives you maximum privacy and a bigger surface area for lots of ink – more detail and brighter colours.

SIZES AVAILABLE

1.8m high x 50m length rolls.
Custom cut panels - 1.8m high x required length.

LITE	
STRENGTH	<div style="width: 75%; height: 10px; background-color: #0056b3;"></div>
HIGH WINDS	<div style="width: 50%; height: 10px; background-color: #0056b3;"></div>
PRIVACY	<div style="width: 75%; height: 10px; background-color: #0056b3;"></div>
PRINT QUALITY	<div style="width: 75%; height: 10px; background-color: #0056b3;"></div>

Lite is the mesh with the best of both worlds, a bit of Max and a bit of Flow. You'll get pretty good privacy and a fair amount of wind can pass through. You won't get fine detail, but the image quality is on the money and colours retain their vibrancy.

SIZES AVAILABLE

1.8m high x 50m length rolls.
Custom cut panels - 1.8m high x required length.

FLOW	
STRENGTH	<div style="width: 50%; height: 10px; background-color: #0056b3;"></div>
HIGH WINDS	<div style="width: 100%; height: 10px; background-color: #0056b3;"></div>
PRIVACY	<div style="width: 50%; height: 10px; background-color: #0056b3;"></div>
PRINT QUALITY	<div style="width: 50%; height: 10px; background-color: #0056b3;"></div>

Flow is our most popular fence mesh, being the most comparable product to it's inferior cousin Shade Cloth. The open weave lets ample wind through, but in doing so, sacrifices a bit of image detail and vibrancy. That said, it is a stunning product that will serve you well.

SIZES AVAILABLE

1.75m high x 50m length rolls.
Custom cut panels - 1.75m high x required length.





POPOP COUNTERS

☼ EZY POP-UP COUNTER

Ezy Pop-Up Counters are sturdy, lightweight and easy to assemble

Ezy Pop-Up Counters are a cost effective portable counter solution ideal for trade show events, exhibitions and product promotions.

The counter is sturdy yet packs away quickly and easily in to two carry cases making it easy to transport.

Comes with a carry case. [See our print template at cq.co.nz](http://www.cq.co.nz)

We also have a tip sheet set up with graphic sizes and assembly instructions.

GRAPHIC DIMENSIONS W: 1720mm x H: 900mm



☼ POP-UP COUNTER

Pop-Up Counters are extremely popular for product launches and trade shows, giving you an instant presentation counter.

This Pop-Up Counter has a light aluminium frame, glossy black bench top and magnetic strips to attach your front banner image. Simple to set up and transport.

Comes with a carry case. [See our print template at cq.co.nz](http://www.cq.co.nz)

GRAPHIC DIMENSIONS W: 1960mm x H: 950mm





DIGITAL CUSTOM CUTTING

With our new custom cutting machine we can now cut and crease to any shape without the need for a traditional die to be made.

We can also cut signage medias like Corflute, Palight, Dispa etc, along with paper stock and self adhesive media.

Some samples below.





WALL GRAPHICS

REMOVABLE WALL GRAPHICS

Our Textile Wallpaper products are like giant post-it notes that can be printed up to 1370mm wide. You can stick this to walls, windows etc and move it at will with little risk of damage. We can cut to any shape with our contour cutter.



❖ CUSTOM WALLPAPER



CUSTOM DESIGN YOUR VERY OWN WALLPAPER!

If you need custom printed wallpaper, CQ can sort you out. Design your own wallpaper for a totally unique interior decor feature. Perfect for the office, home, children's bedrooms, feature walls and more.

The ideas are endless!



Example of wallpaper



Example of wallpaper

❖ WINDOW FROSTING



Looking to keep the sun out or add some privacy - apply some frosting to your window.

We can also make it more interesting with some contour cut shapes and patterns.



WIDE FORMAT PRINTING

Size does matter! Can you imagine Michelangelo's Sistine Chapel painting on a postage stamp? So why settle for your marketing material being printed on A3 paper?

Here at CQ we have the latest in wide format technology, capable of printing on a roll 1.5 metres wide by 30 metres long! We can print on a variety of stocks to complement your work (listed below). If you're not sure which stock would work best for your job, come in and talk to one of our wide format specialists.

WIDE FORMAT MEDIAS

- **WHITE PAPER** - 200gsm. Our most popular white media
- **WHITE PAPER** - 125gsm (best environmental rating) Standard matt stock, FSC Paper
- **SYNTHETIC MEDIA** - 200mic
- **BLOCKOUT** - Blocks light, great for sunny locations, anti curl
- **SALIENT TEXTILE** - 170Mic. For soft posters, textile white cloth
- **ARLON** - Ultra removable, best for wall graphics, can be cut to any shape
- **WALLPAPER** Removable, textured, tough.
- **OUTDOOR BANNER** - Super strong outdoor or indoor banner material, 340gsm, can add eyelets for hanging
- **EASY APPLY** - Air release white label available in **matt** and **gloss** (super easy to apply). Bubble free.
- **CLEAR SELF ADHESIVE** - Clear Sticker Material
- **VINYLS** - 5 year indoor and outdoor vinyls in a variety of colours (non-printable stock)
- **CANVAS** - High grade canvas, talk to us about framing options
- **KRAFT** - Brown Kraft paper 120gsm
- **PERFORATED WINDOW FILM** - See through film for window graphics

DISPLAY UNIT CONSTRUCTION OPTIONS

- **Light Block (standard)**
Falcon Blockout 250mu (great for strong light environments - e.g. a front window)
- **Laminated**
True Colour 125gsm, super strong with matt lamination



FLATBED PRINTING

Our wide format flatbed printer changes the game

- Ability to print direct to media
e.g.: corflute, palight, glass, wood and X board (2440 x 1220mm & 50mm thick)
- Prints white ink
- Great for our environment - no solvents and no ozone
- Produces photographic quality prints
- Inks dry instantly
- Provides more accurate colour matching
- UV inks and LED's produce very little heat which enables us to print onto even more media



WOOD

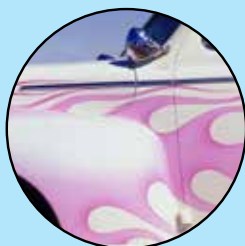

ALUMINIUM



X BOARD

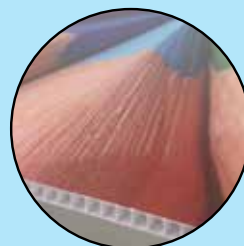

CORFLUTE

SIGNAGE BOARDS



ACM

- 3mm
- Strong rigid board
- Suitable for indoor and outdoor use
- Print direct or apply a sticker
- Suitable for extended outdoor use if used with a vinyl adhesive and laminated. (Max life)



CORFLUTE

- Available in 3.3mm and 5mm
- Cost effective
- Suitable for indoor and outdoor use
- Durable to withstand sunlight and general weather
- Print direct or apply a sticker

NOTE: Matt and Gloss laminating available on all mounting options



DISPA

- 3.3mm
- Eco friendly and recyclable
- Suitable for indoor use
- Print direct



PALIGHT

- Available in 2mm, 3mm and 4mm
- Lightweight indoor signage
- Print direct or apply a sticker
- Can wrap edges with sticker option

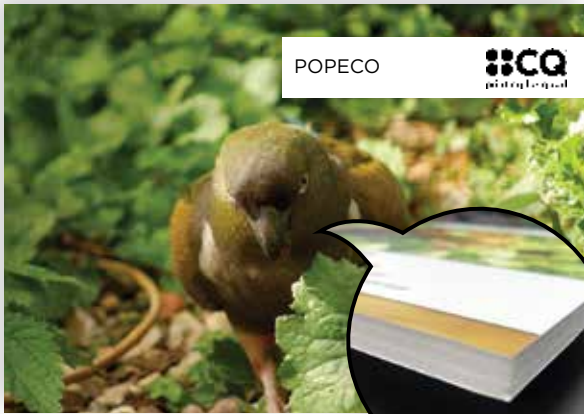

POPECO

- 10mm
- Lightweight
- Rigid and durable
- Suitable for indoor use
- Print direct or apply a sticker

Edging tape optional



KATZ ECO

- 2mm
- Eco friendly & recyclable
- Suitable for indoor or short-term outdoor use
- Water resistant
- Print direct



X BOARD

- 10mm
- Eco friendly and recyclable
- Suitable for indoor use
- Print direct



Silver Eyelet



Mounting Hook For Corflute



Mounting Hook For Ultra Mount



Two sizes of studs available. Gold or silver, and our Cling On product.

Sewing: Used for sewing and eyeleting our banner media

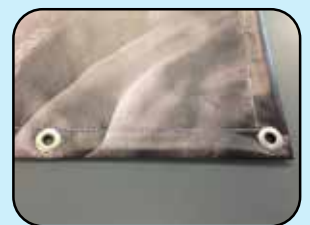



PACKAGING

❖❖ PETAL BOX

These Petal Boxes are sure to impress your customers. Named for the petal-like sides when laid flat, the petals are pulled together at the handle without the need for glue or tape.

DIMENSIONS
H: 140mmH x W: 102mm x D: 106mm

❖❖ PYRAMID BOX

These Pyramid Boxes can be custom branded and personalised with your clients names. These open at the base and can be filled with chocolates or other treats. Perfect when you want something a bit different from the usual.

DIMENSIONS
H: 90mm x W: 100mm x D: 100mm

❖❖ TRIANGLE BOX

These Triangle Boxes can be custom branded and are ideal for wedding favours or corporate gifts.

They fit together with no need for glue or tape and can be printed single or double sided to convey a secret message when opened.

DIMENSIONS
65mm W x 56mm D x 75mm H



PRINTED PAPER BAGS

The perfect environmental choice

We can print these both digitally (small runs) or offset (large runs). With the option of white toner, there are endless opportunities for use.



CHOCOLATE BOXES

Do you want to impress your clients?

What better way than with chocolates in a custom branded box. Our standard chocolate boxes come in three sizes; small, large and extra large or if preferred you can design your own custom size and shape.

DIMENSIONS

Small: 90mm H x 90mm W x 30mm D

Large: 113mm H x 90mm W x 30mm D

Extra Large: 60mm H x 130mm W x 90mm D



CHOCOLATE WRAPS

Personalise a block of chocolate with a custom branded wrap. We have templates for Cadbury and Whittakers chocolate or can design a wrap to your specific size.

Our new mini wraps are perfect for party favours or for the hospitality industry.

A great customer giveaway.



WINE BOXES

Any client will appreciate a bottle of wine but to make a real impression why not present it in a custom printed wine box. These can be printed on white, black or kraft heavy card. Each box has a small window to showcase the bottle inside.

Custom printed packaging not only looks great but shows that your business is professional and adds credibility to your company. We can also print labels or tags for your wine bottles if required.

DIMENSIONS

337mm H x 84mm W x 81mm D



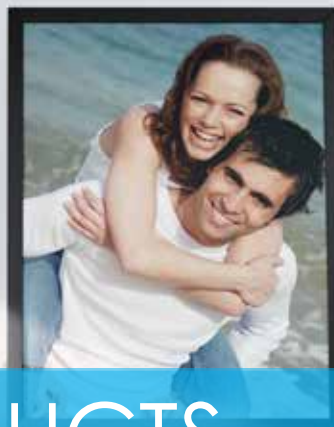

OTHER PRODUCTS



LED INDOOR LIGHT BOXES

LED Indoor Light Box with magnetic cover is our fantastic new product, ideal for advertising your product.

Easy to use, simple magnetic glass cover to replace advertising whenever you feel the need. 230 volts.

DIMENSIONS

Available in sizes
A3, A2, A1 and A0
Depth: 21mm

MITRE FRAMES

Click frames are a great way to display notices, menus, photos and advertising.

Available in a range of sizes and in a silver or black finish.

All supplied with anti glare PVC film cover.

DIMENSIONS

Available in sizes A4, A3, A2, A1 and A0



SUSPENSION BANNER RAILS

This Suspension Banner Rail in aluminium provides classy and cost effective solutions for displaying your graphics.

Easy to use, simply snap open and snap shut at the top and bottom ends of your poster to then suspend from your ceiling or hang from your wall. Includes two U hangers for both wall mounting and ceiling suspension. Supplied in a pack with a top and bottom rail.

DIMENSIONS

W: 600mm | W: 850mm | W: 1000mm | W: 1200mm | W: 1500mm



☼ CANVAS PRINTING

Give a gift with meaning. A special photo or your artwork printed onto stretched and framed canvas makes a great gift for family or friends.

Canvas prints look professional and modern. They can be great advertising in your shop or office. Why not add your company logo to the image? Its inkjet coating is specifically designed so it can be stretched over a frame and resist cracking.



☼ CONTOUR CUTTING

The Amazing Contour Cutter

With our new contour cutter we can cut vinyls up to 1300mm wide to any shape and almost any size. This cutter is so precise that even the smallest or most intricate labels can be cut. Contour cutting is ideal for window and wall graphics, labels, stickers etc.

DIMENSIONS

W: Up to 1300mm wide and down to any size or shape



CQ's contour cut rubbish bin labels



Contour cutter in action



☼ MAGNETS

Custom cut, or large sheets.

We can offer a full range of magnets from custom cut fridge magnets to full sheets up to 1350mm wide. We have a range of samples available to view in store.

DIMENSIONS

Up to A2 size (420 x 594mm)





VEHICLE SIGNAGE



Turn your car into advertising!
We have a range of permanent or removable self-adhesive vinyl medias suitable for short or long-term car signage. Our contour/kiss cutter means your graphics can be cut to any shape or size. Our vehicle graphics are easy to apply yourself or we can install the graphics for you.





Addington Raceway Roundabout

103 Wrights Road

Located on a major Christchurch intersection (Wrights Road & Birmingham Drive), this site captures traffic as it heads into major retail, industrial, entertainment and sporting areas, Addington Raceway and events centre and Wolfbrook Arena. Also, a main road to Westfield Mall and CBD via Blenheim Road.

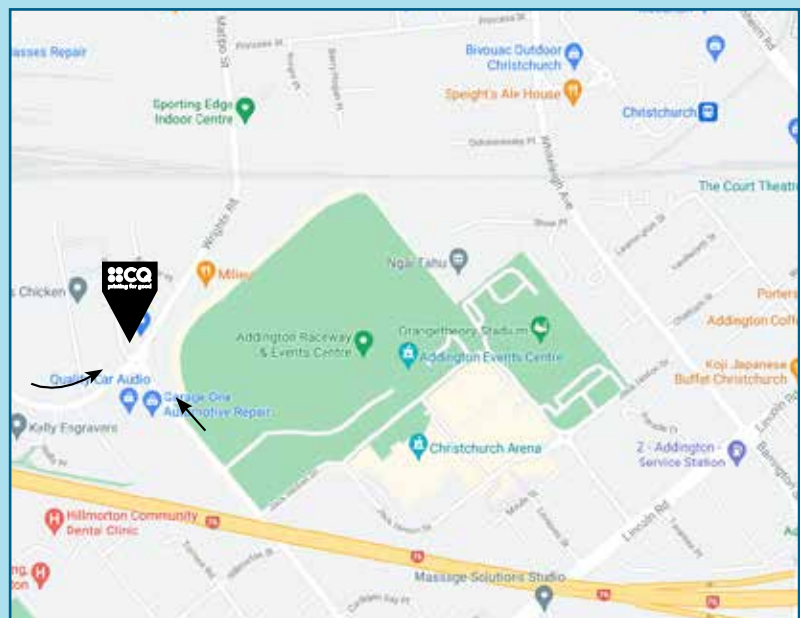

Traffic: 10428 cars a day
Rotation time: 7.5 seconds
Slots available: 8 slots
 Also available half or quarter slots
Media Cycle: Weekly/Monthly
Size: 6 x 3 metres

A0

841 x 1189mm

103 Wrights Road
Cnr Wrights Road and
Birmingham Drive
Christchurch
03 963 8899
info@cq.co.nz

cq.co.nz

A1

594 x 841mm

OVERSIZE

330 x 660mm

A2

SRA3 320 x 450mm

A3

297 x 420 mm

A4

210 x 297mm

A5

148.5 x 210mm

BUSINESS
CARDS
90 x 55mm

DLE
99 x 210mm